

BRCS20P06DP

Rev.C Feb.-2025

描述 / Descriptions

TO-252 塑封封装 P 沟道场效应管。

P-CHANNEL MOSFET in a TO-252 Plastic Package.

特征 / Features

$V_{DS} (V) = -60V$ $I_D = -20A (V_{GS} = \pm 20V)$

$R_{DS(ON)} @ -10V \leq 75m\Omega (Typ. 62m\Omega)$

$R_{DS(ON)} @ -4.5V \leq 100m\Omega (Typ. 70m\Omega)$

无卤产品。HF Product.

用途 / Applications

用于低压电路如：汽车电路、DC/DC 转换、便携式产品的电源高效转换。

Suited for low voltage applications such as automotive, DC/DC Converters, and high efficiency switching for power management in portable and battery operated products.

内部等效电路 / Equivalent Circuit

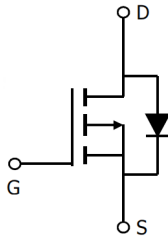

引脚排列 / Pinning

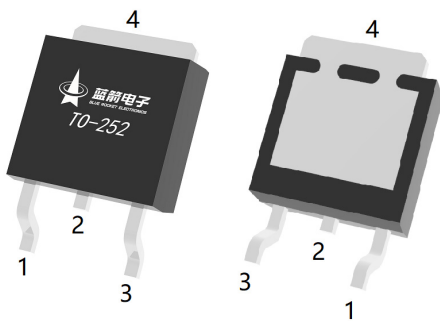

PIN 1 : G

PIN 2 : D

PIN 3 : S

PIN 4 : D

印章代码 / Marking

见印章说明。

See Marking Instructions.

极限参数 / Absolute Maximum Ratings(Ta=25°C)

| 参数 Parameter | 符号 Symbol | 数值 Rating | 单位 Unit |
|--|---------------------------------------|--------------|------------|
| Drain-Source Voltage | V _{DSS} | -60 | V |
| Gate-Source Voltage | V _{GSS} | ±20 | V |
| Continuous Drain Current | I _D (T _c =25°C) | -20 | A |
| Pulsed Drain Current | I _{DM} | -80 | A |
| Avalanche Current | I _{AS} | -13.8 | A |
| Avalanche energy L=0.5mH | E _{AS} | 95 | mJ |
| Power Dissipation for Single Operation | P _D (T _c =25°C) | 45 | W |
| Maximum Junction Temperature | T _j | 150 | °C |
| Storage Temperature Range | T _{stg} | -55 ~ 150 | °C |
| Thermal Resistance-Junction to Ambient | R _{θJA} | 50 | °C/W |
| Thermal Resistance- Junction-to-Case | R _{θJC} | 2.8 | °C/W |

电性能参数 / Electrical Characteristics(Ta=25°C)

| 参数 Parameter | 符号 Symbol | 测试条件 Test Conditions | 最小值 Min | 典型值 Typ | 最大值 Max | 单位 Unit |
|-----------------------------------|----------------------|--|------------|------------|------------|------------|
| Drain-Source Breakdown Voltage | BV _{DSS} | I _D =-250μA V _{GS} =0V | -60 | -69 | | V |
| Zero Gate Voltage Drain Current | I _{DSS} | V _{DS} =-60V V _{GS} =0V | | | -1.0 | |
| Gate-Body leakage current | I _{GSS} | V _{DS} =0V V _{GS} =±20V | | | ±100 | nA |
| Gate Threshold Voltage | V _{GS(th)} | V _{DS} =V _{GS} I _D =-250μA | -1.0 | -1.5 | -2.5 | V |
| Static Drain-Source On-Resistance | R _{DS(ON)} | V _{GS} =-10V I _D =-20A | | 62 | 75 | mΩ |
| | | V _{GS} =-4.5V I _D =-10A | | 70 | 100 | |
| Diode Forward Voltage | V _{SD} | I _S =-1A V _{GS} =0V | | | -1.0 | V |
| Input Capacitance | C _{iss} | V _{GS} =0V V _{DS} =-25V f=1MHz | | 1380 | | pF |
| Output Capacitance | C _{oss} | | | 100 | | |
| Reverse Transfer Capacitance | C _{rss} | | | 65 | | |
| Total Gate Charge | Q _{g(10V)} | V _{GS} =-10V V _{DS} =-30V I _D =-4A | | 20.8 | | nC |
| Total Gate Charge | Q _{g(4.5V)} | | | 10.8 | | |
| Gate-Source Charge | Q _{gs} | | | 3.5 | | |
| Gate-Drain Charge | Q _{gd} | | | 3.6 | | |

电性能参数 / Electrical Characteristics(Ta=25°C)

| 参数 Parameter | 符号 Symbol | 测试条件 Test Conditions | 最小值 Min | 典型值 Typ | 最大值 Max | 单位 Unit |
|---------------------|--------------|--|------------|------------|------------|------------|
| Turn-on Delay Time | $t_{d(ON)}$ | $V_{GS}=-10V$ $V_{DS}=-30V$ $R_L=7.5\Omega$ $R_{GEN}=3\Omega$ | | 8 | | ns |
| Turn-on Rise Time | t_r | | | 3.8 | | |
| Turn-off Delay Time | $t_{d(OFF)}$ | | | 31.5 | | |
| Turn-off Fall Time | t_f | | | 7.5 | | |

电参数曲线图 / Electrical Characteristic Curve

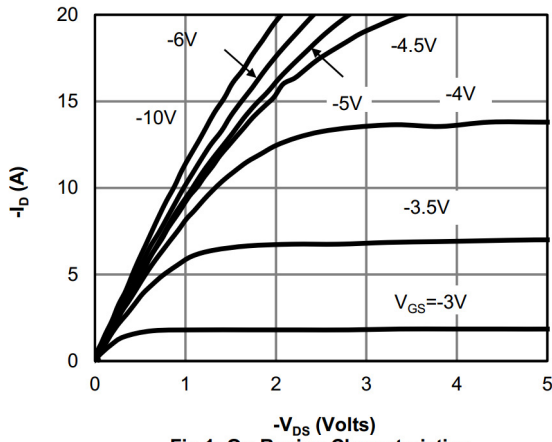

Fig 1: On-Region Characteristics

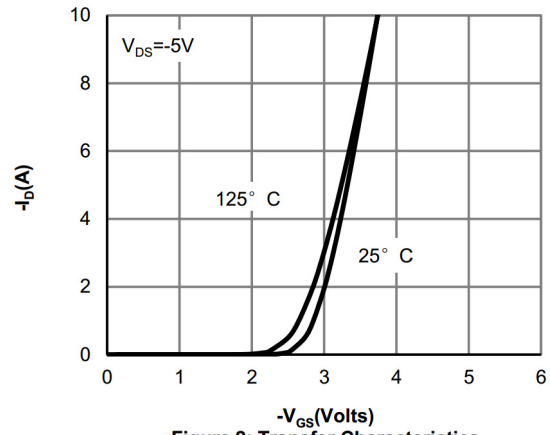

Figure 2: Transfer Characteristics

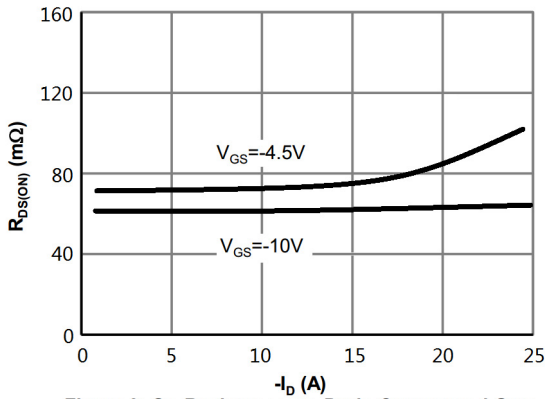

Figure 3: On-Resistance vs. Drain Current and Gate Voltage

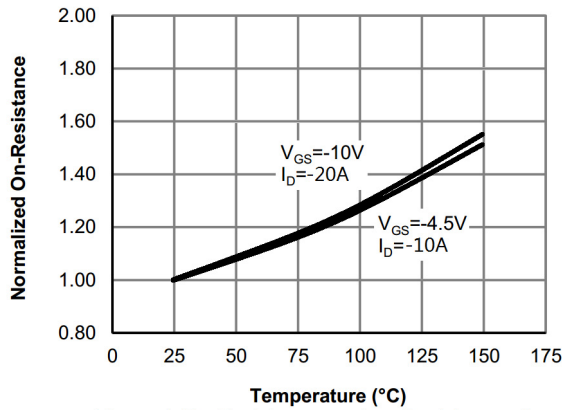

Figure 4: On-Resistance vs. Junction Temperature

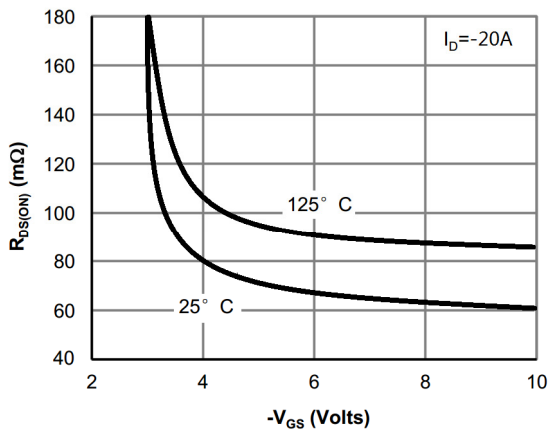

Figure 5: On-Resistance vs. Gate-Source Voltage

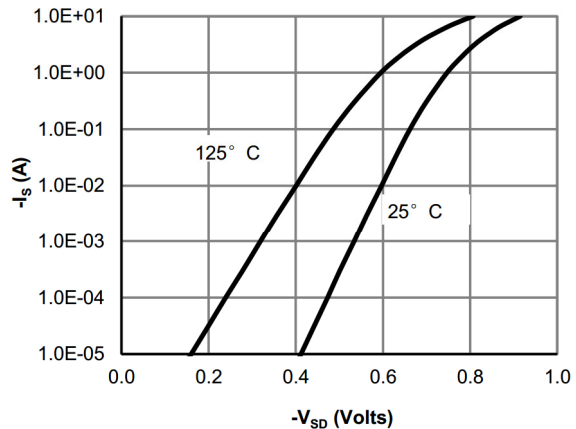

Figure 6: Body-Diode Characteristics

电参数曲线图 / Electrical Characteristic Curve

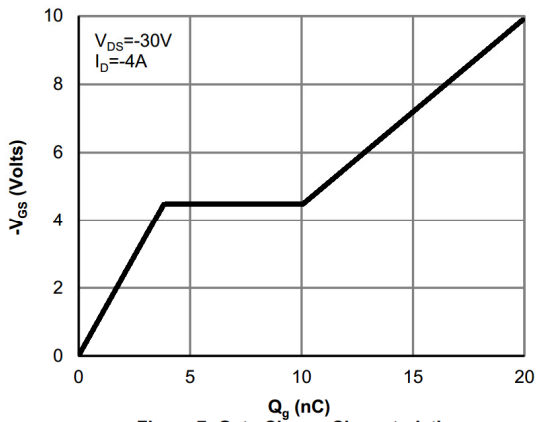

Figure 7: Gate-Charge Characteristics

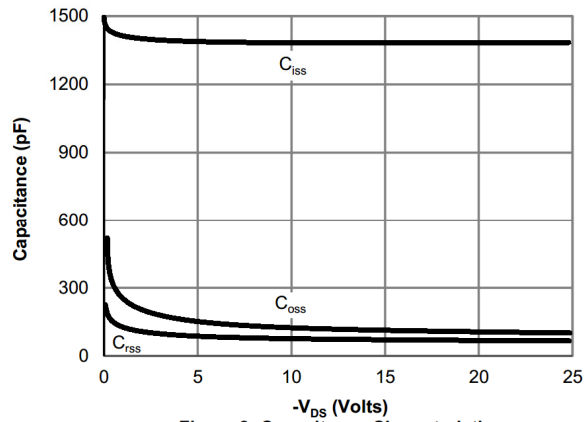

Figure 8: Capacitance Characteristics

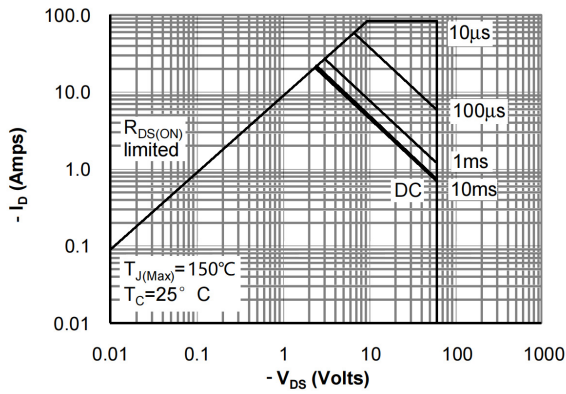

Figure 9: Maximum Forward Biased Safe Operating Area

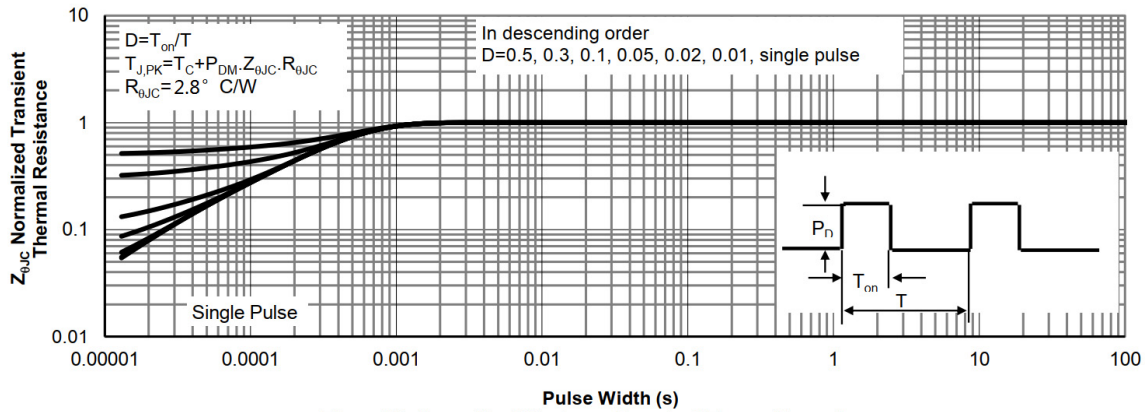
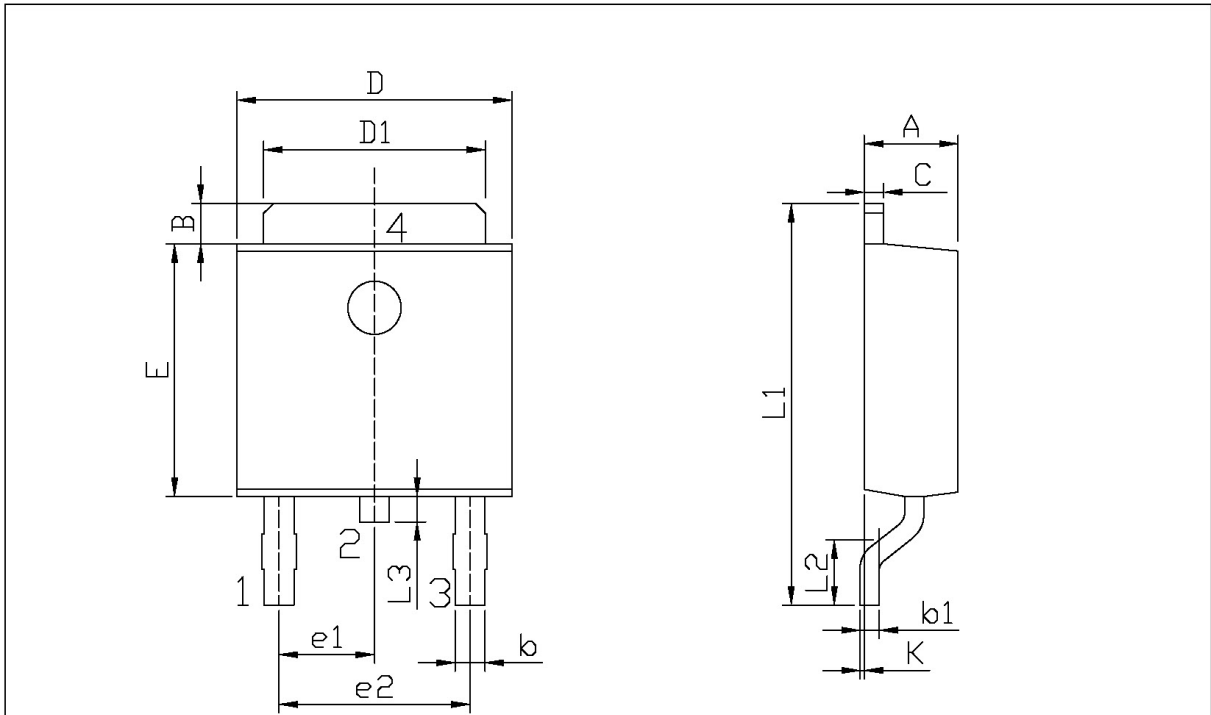

Figure 10: Normalized Maximum Transient Thermal Impedance

外形尺寸图 / Package Dimensions



单位: mm

| Symbol | Dimensions In Millimeters | | Symbol | Dimensions In Millimeters | |
|--------|---------------------------|------|--------|---------------------------|------|
| | Min | Max | | Min | Max |
| A | 2.20 | 2.40 | E | 5.95 | 6.25 |
| B | 0.95 | 1.25 | e1 | 2.24 | 2.34 |
| b | 0.50 | 0.90 | e2 | 4.43 | 4.73 |
| b1 | 0.45 | 0.55 | L1 | 9.45 | 9.95 |
| C | 0.45 | 0.55 | L2 | 1.25 | 1.75 |
| D | 6.45 | 6.75 | L3 | 0.60 | 0.90 |
| D1 | 5.10 | 5.50 | K | 0.00 | 0.10 |

TO-252

印章说明 / Marking Instructions

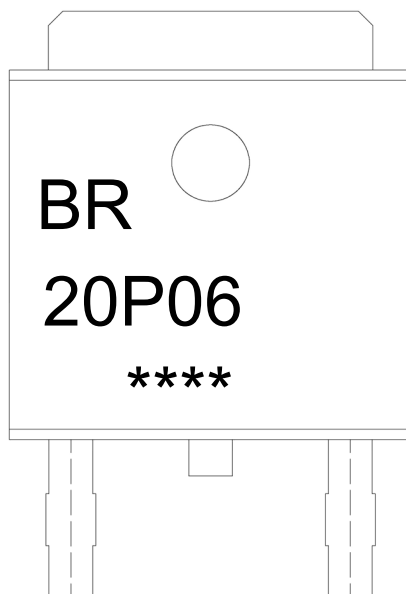

说明：

BR： 为公司代码

20P06： 为型号代码

****： 为生产批号代码，随生产批号变化

Note:

BR: Company Code

20P06: Product Type Code

****: Lot No. Code, code change with Lot No

回流焊温度曲线图(无铅) / Temperature Profile for IR Reflow Soldering(Pb-Free)

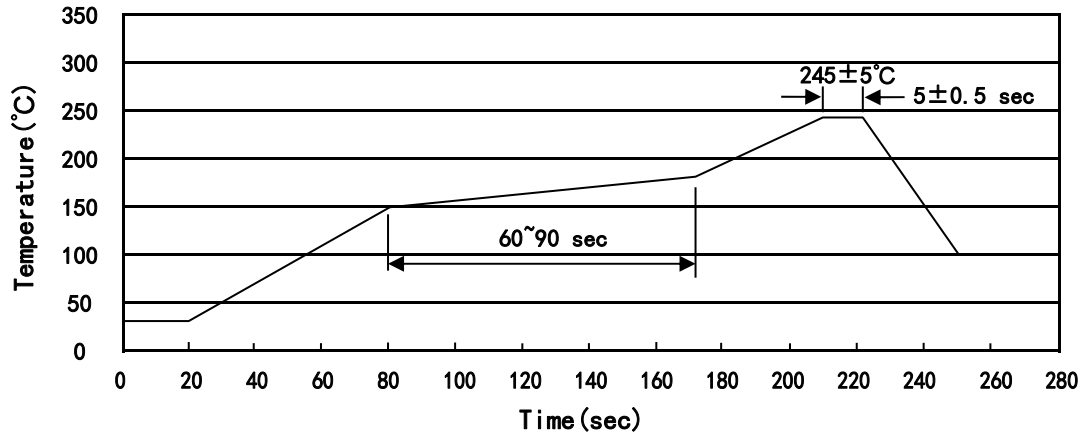

说明：

- 1、预热温度 150~180°C，时间 60~90sec;
- 2、峰值温度 245±5°C，时间持续为 5±0.5sec;
- 3、焊接制程冷却速度为 2~10°C/sec.

Note:

- 1.Preheating:150~180°C, Time:60~90sec.
- 2.Peak Temp.:245±5°C, Duration:5±0.5sec.
3. Cooling Speed: 2~10°C/sec.

耐焊接热试验条件 / Resistance to Soldering Heat Test Conditions

温度：260±5°C

时间：10±1 sec.

Temp.:260±5°C

Time:10±1 sec

包装规格 / Packaging SPEC.

卷盘包装 / REEL

| Package Type 封装形式 | Units 包装数量 | | | | | Dimension 包装尺寸 (unit: mm ³) | | |
|----------------------|--------------------|-------------------------|------------------------|------------------------------|------------------------|---|-------------|-------------|
| | Units/Reel 只/卷盘 | Reels/Inner Box 卷盘/盒 | Units/Inner Box 只/盒 | Inner Boxes/Outer Box 盒/箱 | Units/Outer Box 只/箱 | Reel | Inner Box 盒 | Outer Box 箱 |
| TO-252 | 2,500 | 2 | 5,000 | 6 | 30,000 | 13" ×16 | 360×360×50 | 380×335×366 |

套管包装 / TUBE

| Package Type 封装形式 | Units 包装数量 | | | | | Dimension 包装尺寸 (unit: mm ³) | | |
|----------------------|--------------------|-------------------------|------------------------|------------------------------|------------------------|---|-------------|-------------|
| | Units/Tube 只/套管 | Tubes/Inner Box 套管/盒 | Units/Inner Box 只/盒 | Inner Boxes/Outer Box 盒/箱 | Units/Outer Box 只/箱 | Tube 套管 | Inner Box 盒 | Outer Box 箱 |
| TO-251/252 | 75 | 48 | 3,600 | 5 | 18,000 | 526×20.5×5.25 | 555×164×50 | 575×290×180 |

使用说明 / Notices